

Click to  
**ORDER**  
samples

**AMEL15-JZ**



Encapsulated

The new AMEL15-JZ is a brand-new AC/DC converter that offers much greater cost effectiveness due to material normalization and production automation also leading to improved reliability and performance. Offering a commercial input voltage range of 85-264VAC and an output voltage range from 3.3-24V, this series will offer many benefits to your new system design.

This new series offers great operating temperatures, from -40°C to 70°C with full power also features an isolation of 4000VAC for improved reliability and system safety. Furthermore, a higher MTBF of 300,000h, output short circuit protection (OSCP), output over-current protection (OCP) and an output over-voltage protection (OVP) come standard with the series.

The AMEL15-JZ is perfect for street lighting controls, grid power, LED, instrumentation, industrial controls, communication and civil applications.

**Features**

- Universal Input: 85 - 264VAC/100 - 370VDC
- Operating Temp: -40 °C to +70 °C
- High isolation voltage: 4000VAC
- Low ripple & noise, 50mV(p-p), typ.
- Output short circuit, over-current, over-voltage protection
- Regulated Output

**Summary**

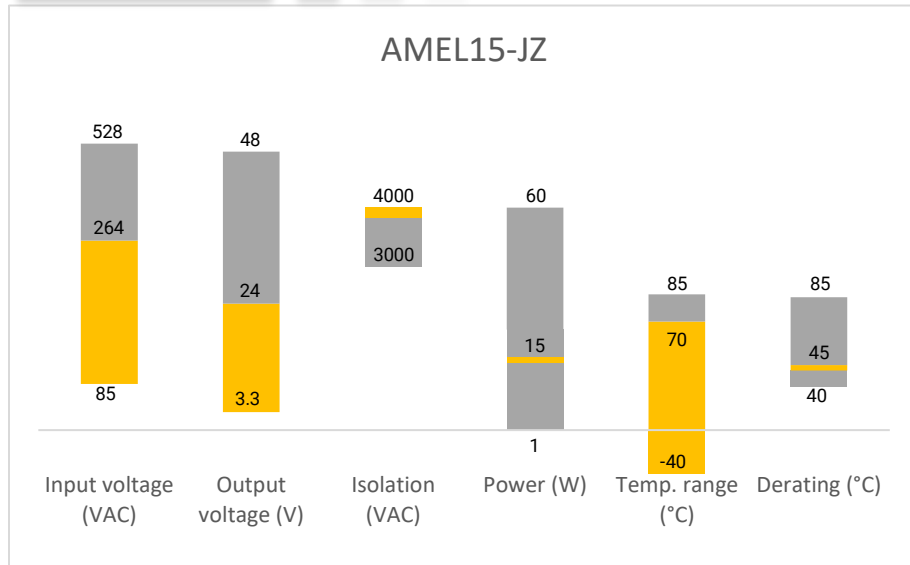

**Training**



Product Training Video  
(click to open)

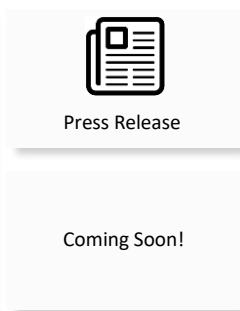

Application Notes

**Applications**



Power Grid

Industrial

Telecom

Instrumentation

## Models & Specifications

Single Output							
Model	Input Voltage (VAC/Hz)	Input Voltage (VDC)	Max Output wattage (W)	Output Voltage (V)	Output Current max (A)	Maximum capacitive load (μF)	Efficiency @ 230VAC (%)
AMEL15-3.3SJZ	85-264/47-63	100-370	8.9	3.3	2.70	10,000	72
AMEL15-5SJZ	85-264/47-63	100-370	13.5	5	2.70	6,600	76
AMEL15-9SJZ	85-264/47-63	100-370	15	9	1.66	4,400	77
AMEL15-12SJZ	85-264/47-63	100-370	15	12	1.25	3,000	80
AMEL15-15SJZ	85-264/47-63	100-370	15	15	1.00	2,000	81
AMEL15-24SJZ	85-264/47-63	100-370	15	24	0.625	800	81

Input Specifications					
Parameters	Conditions	Minimum	Typical	Maximum	Units
Current	115VAC		0.27	0.32	A
	230VAC		0.17	0.20	A
Inrush current <2ms (cold start)	115VAC		12		A
	230VAC		36		A
External fuse	slow blow type	3.15			A

Output Specifications				
Parameters	Conditions	Typical	Maximum	Units
Voltage accuracy	3.3V output	±3		%
	Others	±2		%
Line regulation	Full load	±0.5		%
Load regulation	0-100% load	±1		%
Ripple & Noise	20MHz bandwidth	50	120	mV p-p
Hold up time	230VAC	55		ms

\*Ripple and Noise are measured at 20MHz bandwidth by using the referenced Application circuit.

Isolation Specifications				
Parameters	Conditions	Typical	Rated	Units
Tested I/O voltage	60 sec		4000	VAC

General Specifications				
Parameters	Conditions	Typical	Maximum	Units
Switching frequency	100% load	100		KHz
Protection class	Class II			
Over Current protection	Auto recovery	≥130		% of Iout
Over voltage protection	3.3V/5V Vout		≤7.5	VDC
	9V Vout		≤15	
	12V/15V Vout		≤20	
	24V Vout		≤30	
Short circuit protection	Continuous			
Short circuit restart	Auto recovery			
Operating temperature	See derating graph	-40 to +70		°C
Maximum case temperature			100	°C
Storage temperature		-40 to +85		°C
Lead temperature	Wave soldering	260 ± 5°C; time : 5 - 10s		
	Hand soldering	360 ± 10°C; time : 3 - 5s		
Temperature coefficient		±0.02		% / °C
Cooling	Free air convection			
Humidity	Non-condensing	95		% RH
Case material	Heat resistant black Plastic (flammability to UL 94V-0)			
Weight	PCB mountable models	60		g
	With optional -ST mounting plate:	80		
	With optional -STD mounting plate:	100		
Dimensions (L x W x H)	PCB mountable models	2.11 x 1.13 x 0.93 inches (53.8 x 28.8 x 23.5mm)		
	With optional -ST mounting plate:	2.99 x 1.24 x 1.27 inches (76 x 31.5 x 32.3mm)		
	With optional -STD mounting plate:	2.99 x 1.24 x 1.45 inches (76 x 31.5 x 36.9mm)		
MTBF	> 300 000 hrs (MIL-HDBK -217F, t=+25°C)/Full Load			

NOTE: All specifications in this datasheet are measured at an ambient temperature of 25°C, humidity<75%, nominal input voltage and at rated output load unless otherwise specified.

Safety Specifications			
Parameters			
Agency approvals	cULus		
Standards	Information technology Equipment	IEC/EN/UL 62368, UL 60950	
	EMC - Conducted and radiated emission	CISPR32 / EN55032, class B	
	Electrostatic Discharge Immunity	IEC 61000-4-2 Contact ±6KV / Air ±8KV, Criteria B	
	RF, Electromagnetic Field Immunity	IEC 61000-4-3 10V/m, Criteria A	
	Electrical Fast Transient/Burst Immunity	IEC 61000-4-4 ±4KV, Criteria B	
	Surge Immunity	IEC 61000-4-5 L-L ±2KV, with typical application circuit, Criteria B	
		IEC 61000-4-5 L-L ±4KV/L-G ±6KV, with EMC recommended circuit, Criteria B	
	RF, Conducted Disturbance Immunity	IEC 61000-4-6 10Vr.m.s, Criteria A	
Voltage dips, Short Interruptions Immunity	IEC 61000-4-11 0%, 70%, Criteria B		

Derating

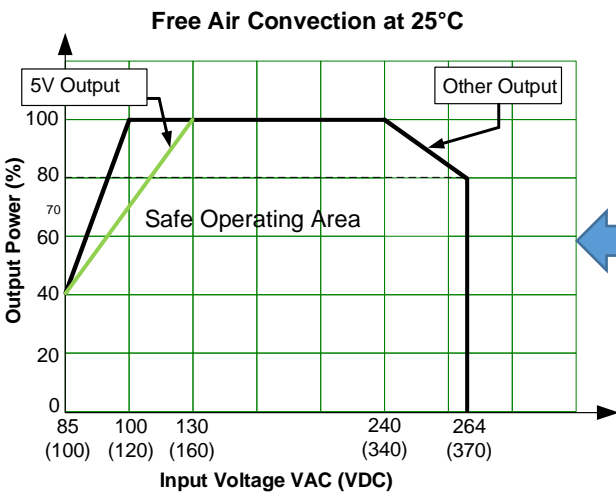
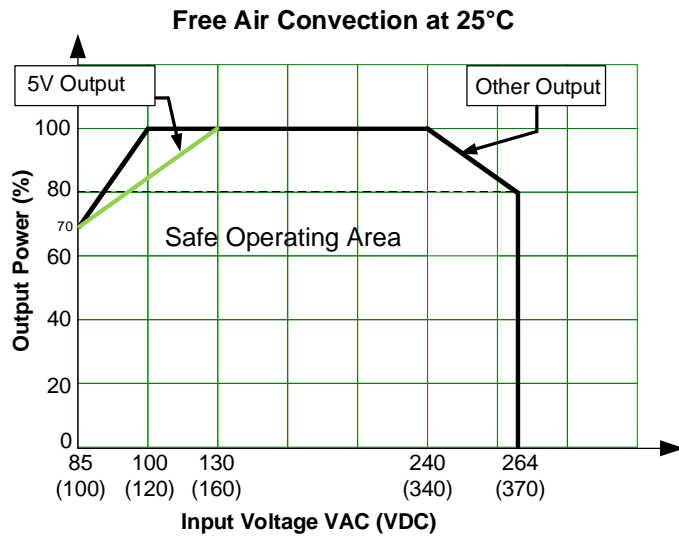
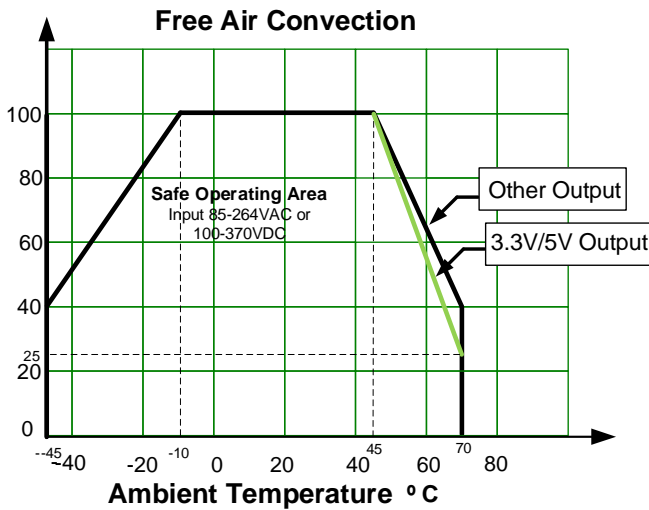

Operating temperature: -25...+70C

Operating temperature: -40...+70C

Typical Application Circuit

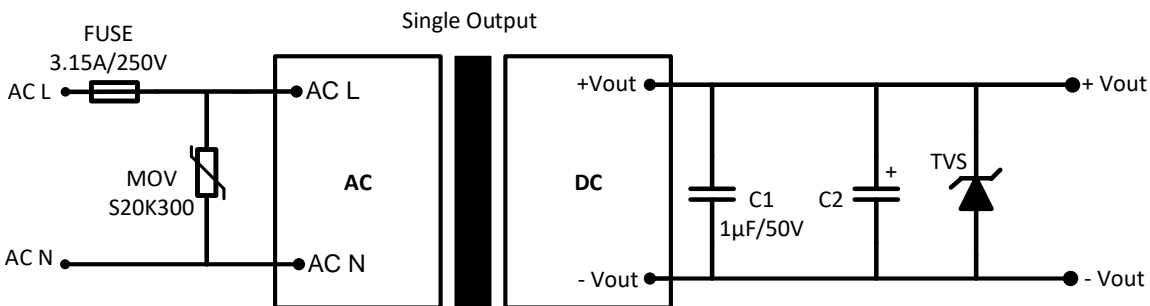

## Surge Immunity Recommended Circuit

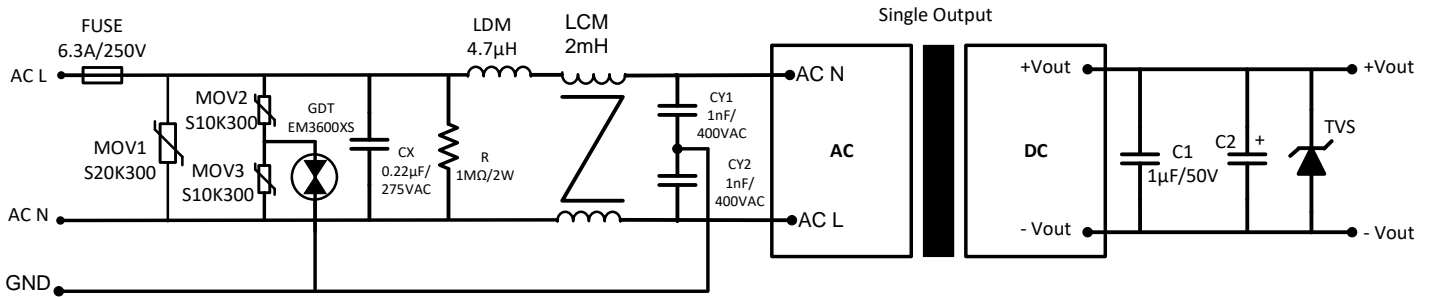

Model	C2		TVS
	Normal load	For high frequency switching load	
3.3 & 5 Vout	220 µF / 10V	470µF/16V (Solid capacitor)	7V
9Vout	120 µF / 25V	470µF/16V (Solid capacitor)	12V
12 & 15 Vout	120 µF / 25V	390µF/25V	20V
24 Vout	68 µF / 35V	220µF/35V	30V

## Dimensions

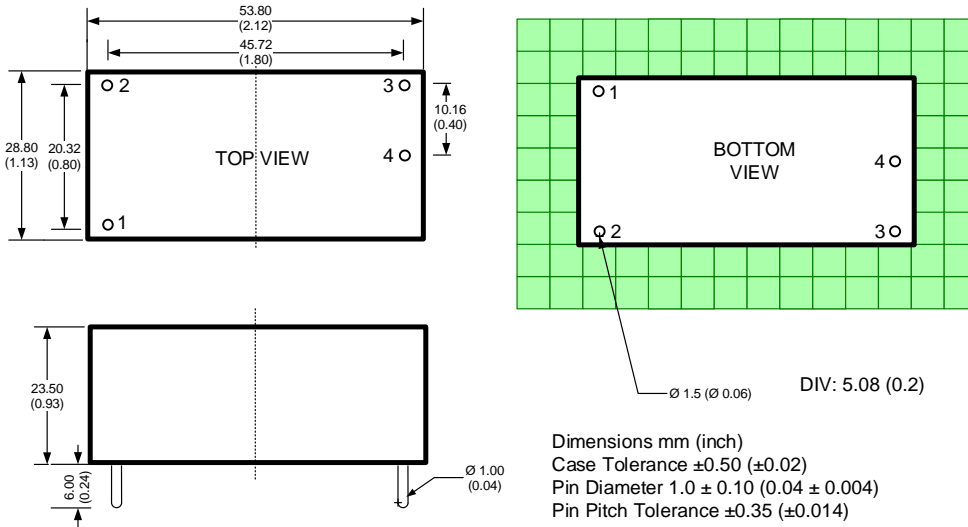

Pin Output Specifications	
Pin	Single
1	AC Input (L)
2	AC Input (N)
3	+V Output
4	-V Output

Dimensions with ST Optional

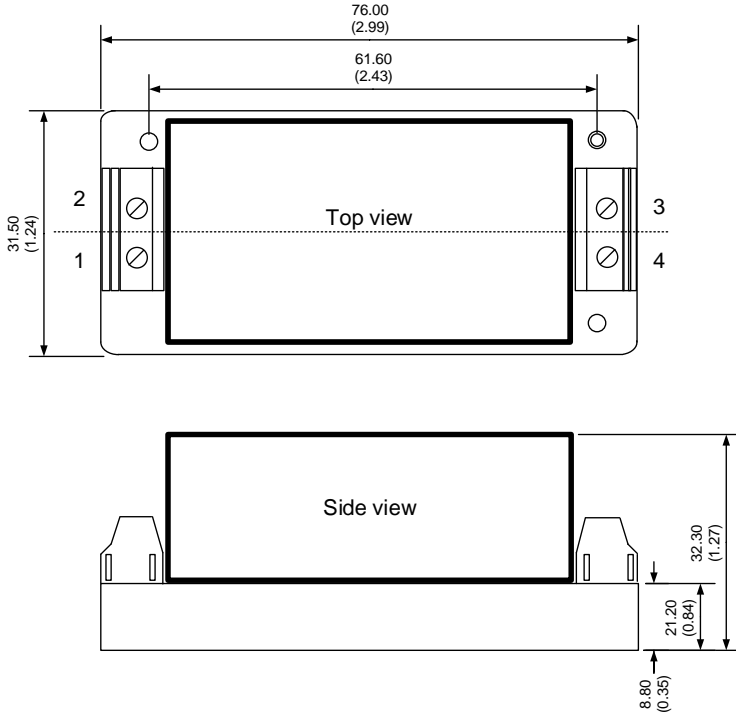

Pin Output Specifications	
Pin	Single
1	AC Input (L)
2	AC Input (N)
3	+V Output
4	-V Output

**NOTE:** **1.** Datasheets are updated as needed and as such, specifications are subject to change without notice. Once printed or downloaded, datasheets are no longer controlled by Aimtec; refer to [www.aimtec.com](http://www.aimtec.com) for the most current product specifications. **2.** Product labels shown, including safety agency certifications on labels, may vary based on the date manufactured. **3.** Mechanical drawings and specifications are for reference only. **4.** All specifications are measured at an ambient temperature of 25°C, humidity<75%, nominal input voltage and at rated output load unless otherwise specified. **5.** Aimtec may not have conducted destructive testing or chemical analysis on all internal components and chemicals at the time of publishing this document. CAS numbers and other limited information are considered proprietary and may not be available for release. **6.** This product is not designed for use in critical life support systems, equipment used in hazardous environments, nuclear control systems or other such applications which necessitate specific safety and regulatory standards other the ones listed in this datasheet. **7.** Warranty is in accordance with Aimtec's standard Terms of Sale available at [www.aimtec.com](http://www.aimtec.com).