

Series AMEL5-CJZ

5 Watt | AC-DC / DC-DC Converter

FEATURES:



- I/O Isolation 4000VAC
- Operating Temp: -25 °C to +70 °C
- Input: 85-264VAC, 47-63Hz, or 100-370VDC
- Over current, Over Voltage Protection
- High efficiency up to 83%
- No load consumption $\leq 0.3W$
- Ultra-small package
- Short Circuit Protection

Models Single output



Model	Input Voltage (VAC/Hz)	Input Voltage (VDC)	Output Voltage (V)	Output Current max (A)	Maximum capacitive Load (μF)	Efficiency (%)
						230 VAC
AMEL5-3.3SCJZ	85-264/47-63	100-370	3.3	1.25	4000	74
AMEL5-5SCJZ	85-264/47-63	100-370	5	1	4000	78
AMEL5-9SCJZ	85-264/47-63	100-370	9	0.55	1000	78
AMEL5-12SCJZ	85-264/47-63	100-370	12	0.42	820	80
AMEL5-15SCJZ	85-264/47-63	100-370	15	0.333	820	82
AMEL5-24SCJZ	85-264/47-63	100-370	24	0.23	330	83

Add suffix “-ST” for optional screw terminal bottom plate or “-STD” for optional DIN Rail screw terminal bottom plate.

Input Specifications

Parameters	Conditions	Typical	Maximum	Units
Current (full load)	115 VAC		150	mA
	230 VAC		70	mA
Inrush current <2ms (cold start)	115 VAC	10		A
	230 VAC	20		A
External fuse	Recommended slow blow type	1.5		A
Input Dissipation (No Load)	No load (110/230VAC)		0.3	W

Output Specifications

Parameters	Conditions	Typical	Maximum	Units
Voltage accuracy	3.3V output	± 3		%
	Others	± 2		%
Line regulation		± 0.5		%
Load regulation	10-100% load	± 1		%
Ripple & Noise *	20MHz Bandwidth, 3.3 / 5V models	60	120	mV p-p
	20MHz Bandwidth, others	50	100	
Hold-up time (minimum)	115VAC	12		ms
	230VAC	80		

*Ripple and Noise are measured at 20MHz bandwidth by using the referenced Application circuit.

Isolation Specifications

Parameters	Conditions	Typical	Rated	Units
Tested I/O voltage	60 sec	4000		VAC
Isolation Resistance		>1000		M Ω

General Specifications

Parameters	Conditions	Typical	Maximum	Units
Switching frequency		140		KHz
Protection class		Class II		
Over Current protection	Auto recovery	≥ 110		% of Iout
Over voltage protection		Zener diode clamp		
Short circuit protection		Continuous, hiccup, Auto recovery		
Operating temperature	See derating curve	-25 to 70°C		°C
Storage temperature		-25 to +105		°C
Maximum Case temperature			100	°C

Temperature coefficient		0.02		% /°C
Cooling	Free air convection			
Humidity	Non-condensing		95	% RH
Case material	Plastic (flammability to UL 94V-0)			
Weight	PCB mountable models	31		g
	With optional -ST mounting plate:	52		
	With optional -STD mounting plate:	70		
Dimensions (L x W x H)	PCB mountable models	2.0 x 1.0 x 0.6 inches	50.80 x 25.40 x 15.16mm	
	With optional -ST mounting plate:	2.99 x 1.24 x 0.94 inches	76.00 x 31.50 x 23.96mm	
	With optional -STD mounting plate:	2.99 x 1.24 x 1.02 inches	76.00 x 31.50 x 25.80mm	
MTBF	> 300,000 hrs (MIL-HDBK -217F, t=+25°C)/Full Load			

NOTE: All specifications in this datasheet are measured at an ambient temperature of 25°C, humidity<75%, nominal input voltage and at rated output load unless otherwise specified.

Safety Specifications

Parameters		
Agency approvals	cULus	
Standards	IEC/EN/UL 60950-1 (except AMEL5-9SCJZ), IEC/EN/UL 60601-1	
	EMI - Conducted and radiated emission	EN55022, class B
	Electrostatic Discharge Immunity	IEC 61000-4-2, Contact: ±4KV/Air: ±8KV, Criteria B
	RF, Electromagnetic Field Immunity	IEC 61000-4-3, 10V/m, Criteria A
	Electrical Fast Transient/Burst Immunity	IEC 61000-4-4, ±2KV, Criteria B
	Surge Immunity	IEC 61000-4-5, ±1KV/±2KV, Criteria B
	RF, Conducted Disturbance Immunity	IEC 61000-4-6, 10Vrms, Criteria A
	Power frequency Magnetic Field Immunity	IEC 61000-4-8, 10A/m, Criteria A
	Voltage dips, Short Interruptions Immunity	IEC 61000-4-11, 0-70%, Criteria B

Dimensions

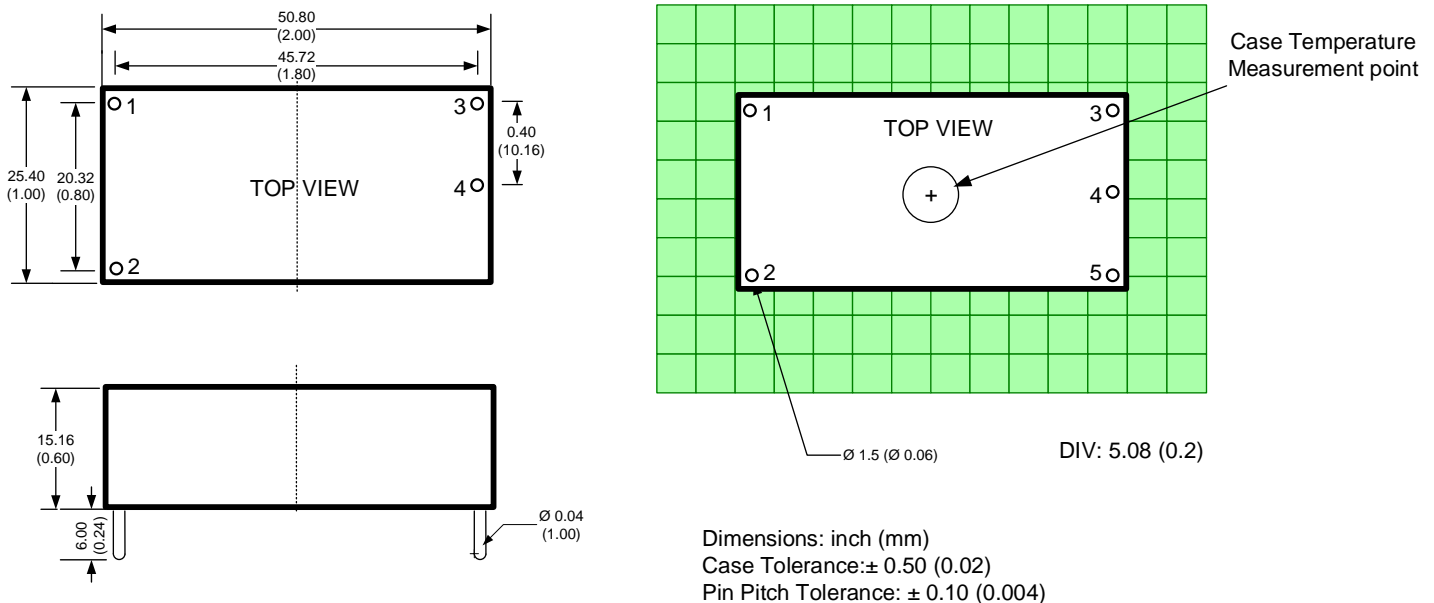

Pin Out Specifications

Pin	Single
1	AC Input (N)
2	AC Input (L)
3	+V Output
4	-V Output

Dimensions with -ST options

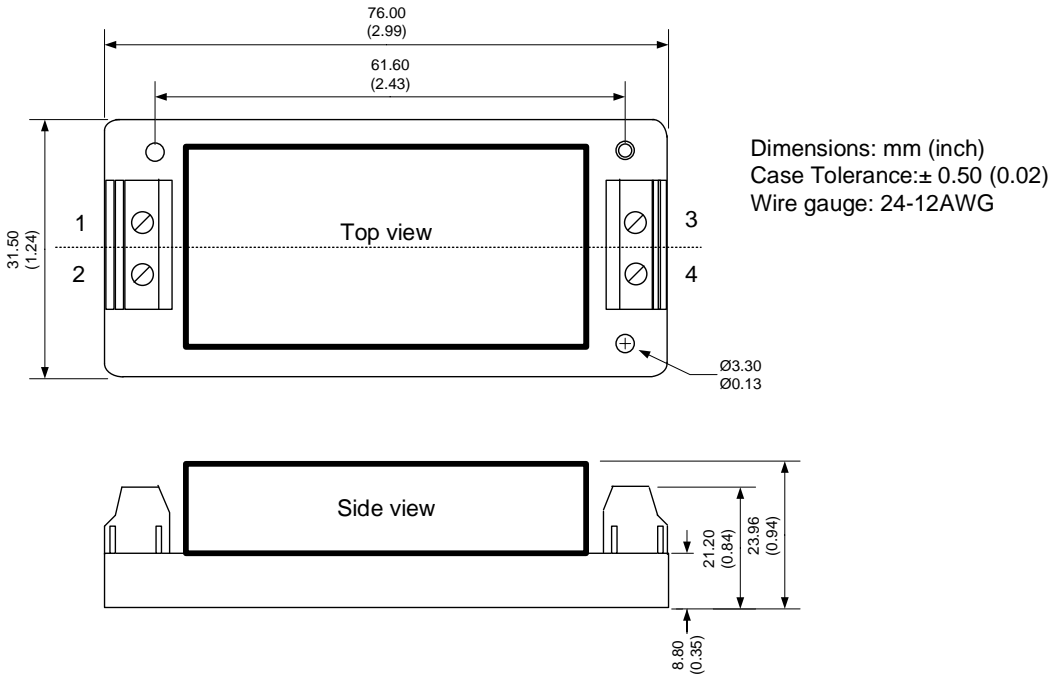

Pin Out Specifications

Pin	Single
1	AC Input (N)
2	AC Input (L)
3	+V Output
4	-V Output

Dimensions with -STD options

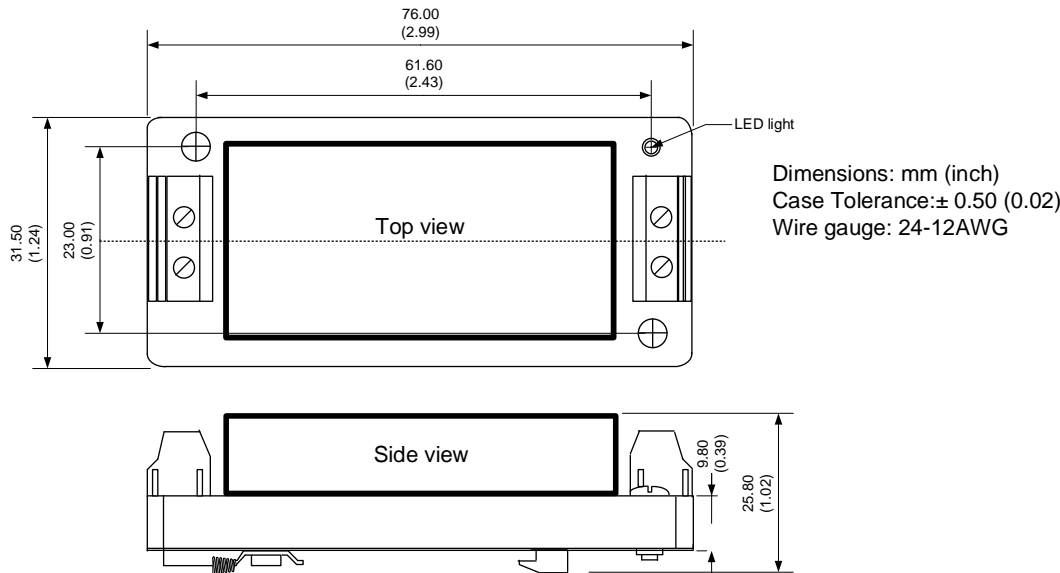

Pin Out Specifications

Pin	Single
1	AC Input (N)
2	AC Input (L)
3	+V Output
4	-V Output

Typical application circuit

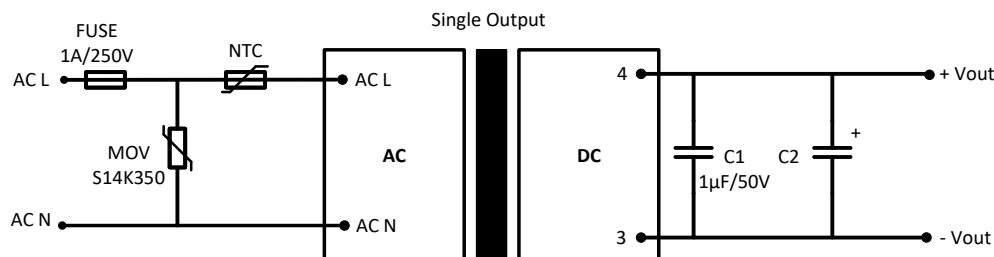

Model	C2
3.3 & 5 Vout	220 µF / 35V
9, 12 & 15 Vout	120 µF / 35V
24 Vout	47 µF / 35V

Derating

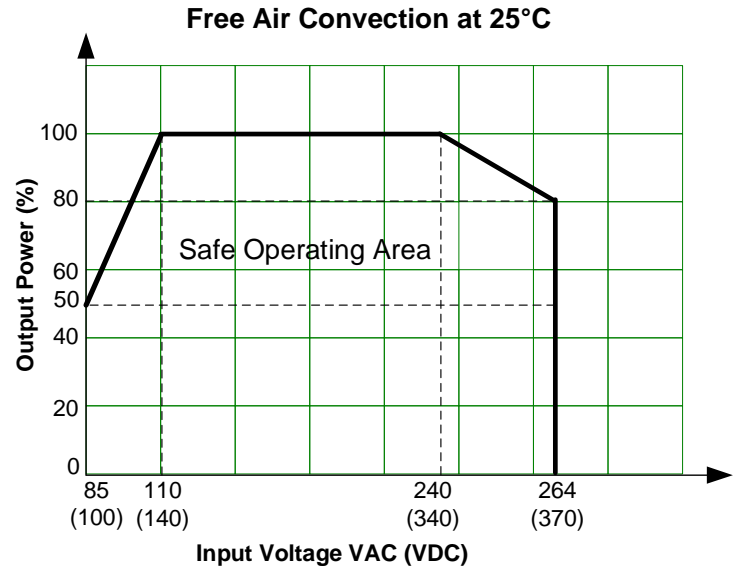
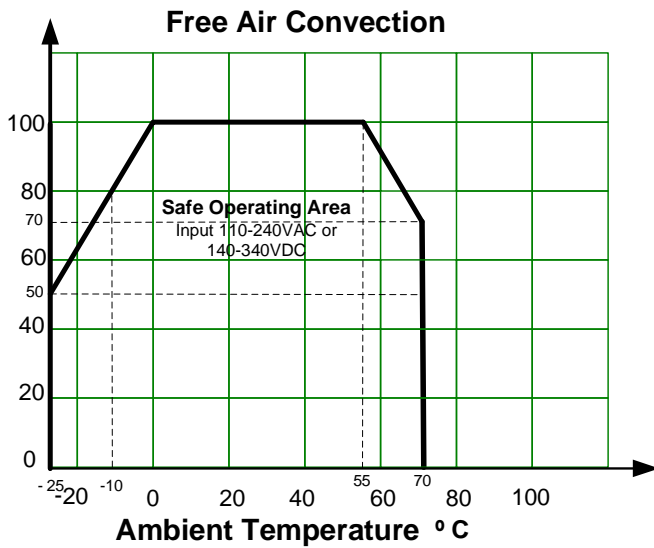

Typical application circuit

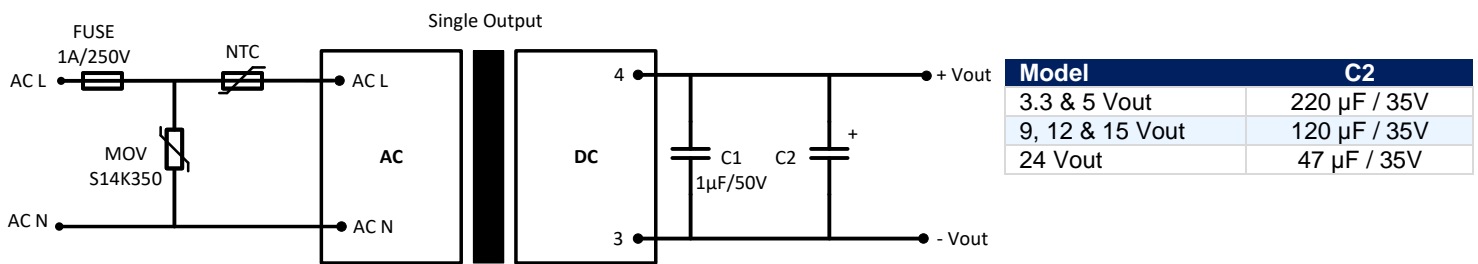

EMC recommended circuit to meet IEC 61000-4-4: ±4KV & IEC 61000-4-5: ±2KV/±4KV

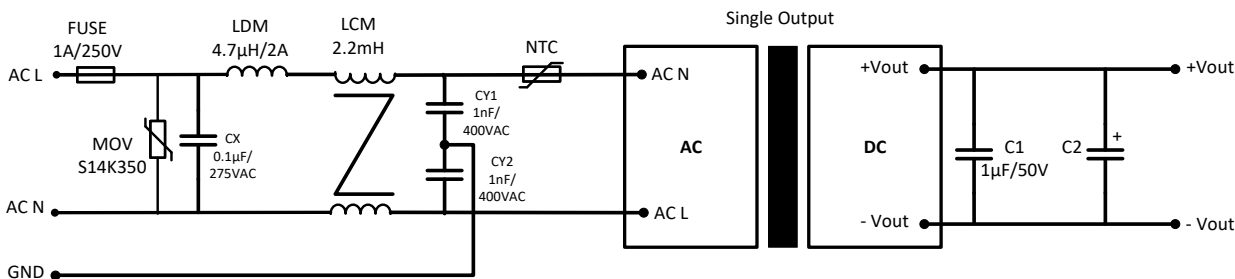

Model	C2
3.3 & 5 Vout	220 µF / 35V
9, 12 & 15 Vout	120 µF / 35V
24 Vout	47 µF / 35V

NOTE: 1. Datasheets are updated as needed and as such, specifications are subject to change without notice. Once printed or downloaded, datasheets are no longer controlled by Aimtec; refer to www.aimtec.com for the most current product specifications. 2. Product labels shown, including safety agency certifications on labels, may vary based on the date manufactured. 3. Mechanical drawings and specifications are for reference only. 4. All specifications are measured at an ambient temperature of 25°C, humidity < 75%, nominal input voltage and at rated output load unless otherwise specified. 5. Aimtec may not have conducted destructive testing or chemical analysis on all internal components and chemicals at the time of publishing this document. CAS numbers and other limited information are considered proprietary and may not be available for release. 6. This product is not designed for use in critical life support systems, equipment used in hazardous environments, nuclear control systems or other such applications which necessitate specific safety and regulatory standards other than the ones listed in this datasheet. 7. Warranty is in accordance with Aimtec's standard Terms of Sale available at www.aimtec.com.